

Restrictor Valve with Reverse Flow Check, Modular

VSO3-10/M

Size 10 (D05) •  $Q_{max}$  160 l/min (42 GPM) •  $p_{max}$  350 bar (5100 PSI)



Technical Features

- › Restrictor valve with reverse flow check with subplate mounting surface acc. to ISO 4401, DIN 24340 (CETOP 05) standards
- › Meter-in or meter-out flow control
- › Leak-free closure in one or two service ports
- › Linear adjustment and positive seat closing
- › Desired settings may be locked down
- › Adjustment option with allen head and protective cup
- › In the standard version, the valve is zinc coated for 240 h protection acc. to ISO 9227 and valve body is phosphated

Functional Description

Dual hydraulic flow restrictor valve with by pass check valve option are used to control flow rates in two separate lines (A,B) of a hydraulic circuit. The modular design provides six functional versions. The valve restricts the fluid flow in one direction while providing reverse free-flow in the opposite direction. The throttling is adjusted by means of a set screw. The sandwich design enables simple stacking with other components of the same size. The separate o-ring plate with fitted o-rings provides sealing of the valve connecting surface. According to the valve arrangement, the meter-in or meter-out control is provided. Changing the meter-in mode into the meter-out mode can be done by turning the valve by 180° around its x-axis. The orientation of the throttle check valves in the valve body corresponds with the symbols shown on the nameplate. The set screw can be operated by a key, handknob or by a handknob with key lock.

ISO 4401-05-04-0-05

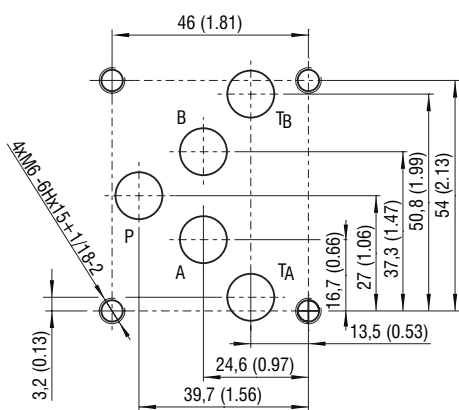

Ports P, A, B, T - max  $\varnothing$ 11.2 mm (0.44 in)

Technical Data

Valve size		10 (D05)
Max. flow	l/min (GPM)	160 (42)
Max. operating pressure	bar (PSI)	350 (5080)
Fluid temperature range (NBR)	°C (°F)	-30 ... +100 (-22 ... +212)
Fluid temperature range (FPM)	°C (°F)	-20 ... +120 (-4 ... +248)
Weight	kg (lbs)	2.15 (4.74)

	Datasheet	Type
General information	GI_0060	products and operating conditions
Mounting interface	SMT_0019	Size 06
Spare parts	SP_8010	

Characteristics measured at  $v = 32 \text{ mm}^2/\text{s}$  (156 SUS)

Pressure drop related to flow rate

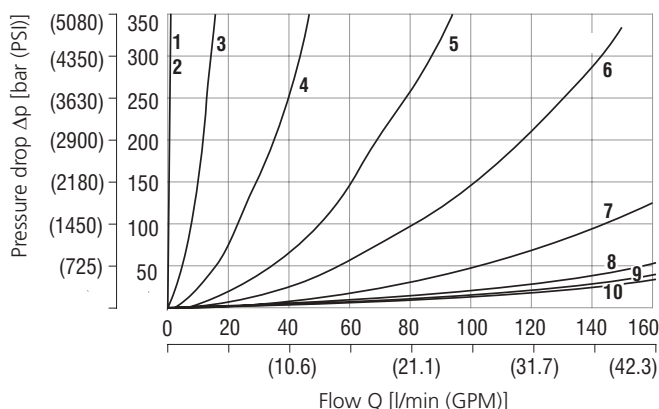

Number of turns the screw										
2	3	4	5	6	7	8	9	10	11	

Check valve pressure drop related to flow rate

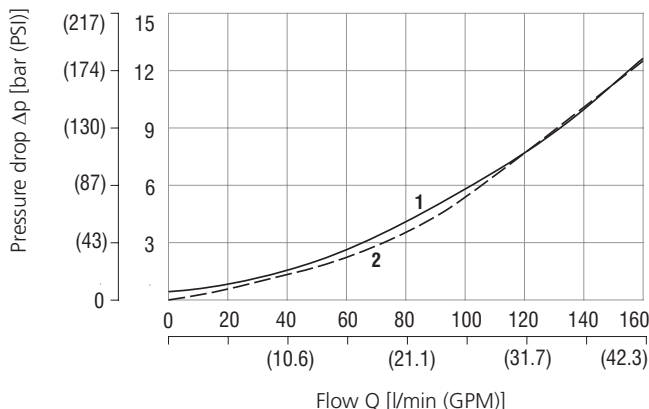

Throttle valve closed	Throttle fully open
1	2

**Dimensions** in millimeters (inches)

**Model "C,,**

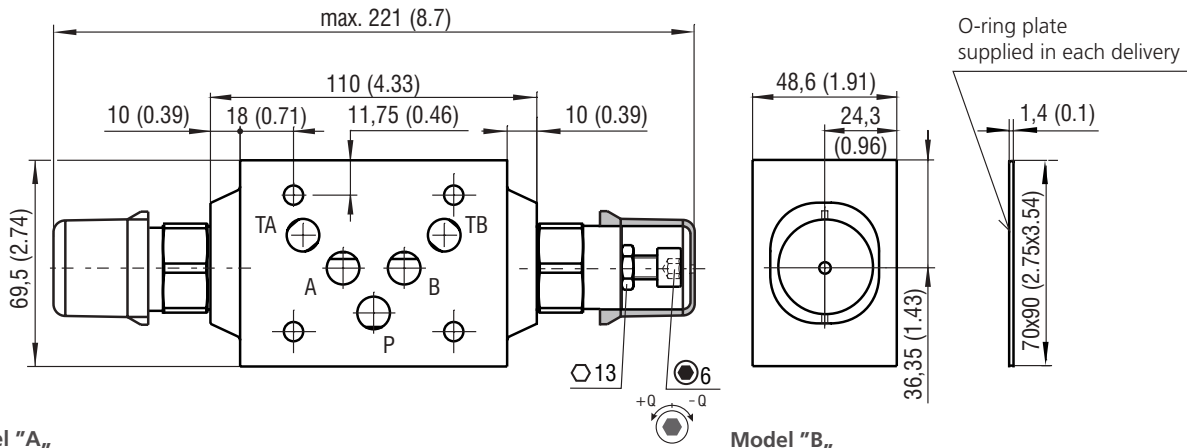

**Model "A,,**

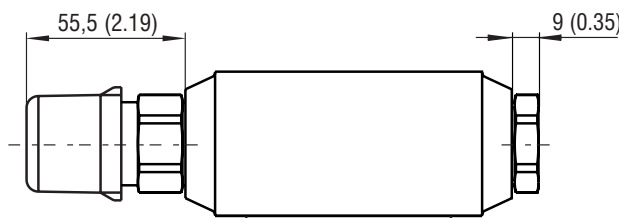

**Model "B,,**

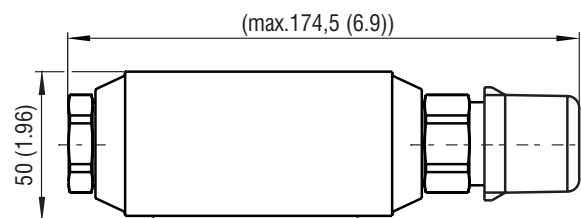

**Functional symbols**

**VSO3-10/MA**

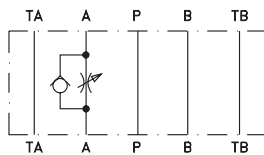

**VSO3-10/MB**

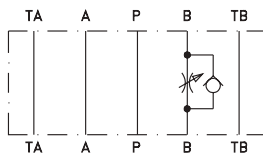

**VSO3-10/MC**

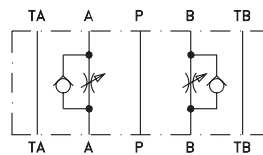

**Caution!**

The orientation of the symbol shown on the name plate corresponds with the function of the valve. The separate o-ring plate allows to turn around the body. The meter-out throttling can be changed to the meter-in throttling by simple rotating the plate only at MC type. At the types MA and MB, the valve position in channels A and B is changed due to the one axis symmetry of the mounting interface of modular plate. This can be solved by ordering the opposite type (see table below) or by additional changing the valve and end plug positions each other.

Recommended types depending on valve position and throttling mode:

Type / valve in channel	Meter-out throttling	Meter-in throttling
MA / A	VSO3-10/MA	VSO3-10/MB, turn the plate
MB / B	VSO3-10/MB	VSO3-10/MA, turn the plate
MC / A, B	VSO3-10/MC	VSO3-10/MC, turn the plate

**Ordering Code**

**VSO3 - 10 / M**    -

**Restrictor valve with reverse flow check, modular**

**Valve size**

**Modular design**

**Functional symbols**

Check valve in line A, meter-out  
 Check valve in line B, meter-out  
 Check valve in line A and B, meter-out

**A**  
**B**  
**C**

**No designation**

**Surface treatment**  
 phosphated body, valve for 240 h salt spray test (ISO 9227)  
**A** body and valve for 240 h salt spray test (ISO 9227)  
**B** body and valve for 520 h salt spray test (ISO 9227)

**No designation**  
**V**

**Seals**  
 NBR  
 FPM (Viton)

**Adjustment option**  
 allen head (hex.5) with protective cap

The valves are assembled in meter-out version.  
 To get meter-in version for variant MC with valves in both channels, just turn it.  
 Remember: the channels A and B are changed in meter-in version.  
 It is important when meter-in is required for variant MA or MB.