



KİR, YAĞ ve TOZA
KARŞI ÜSTÜN
KORUMA

PST SERİSİ

ISO 15552 // $\varnothing 32$ - $\varnothing 125$

ALÜMİNYUM BORULU, SAPLAMALI
MANYETİK ve YASTIKLAMALI SİLİNDİR



- Tozlu ve kirli ortamlar için mil keçesi opsiyonu. (K5: POM+PU)



- Yoğun kirli, yağlı ve tozlu ortamlar için mil keçesi opsiyonu. (K6: Bronz+PU)



PST SERİSİ

ISO 15552 // Ø32 - Ø125

ALÜMİNYUM BORULU, SAPLAMALI
MANYETİK ve YASTIKLAMALI SİLİNDİR

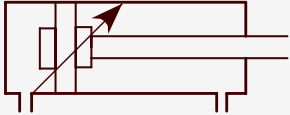

PST
ÇİFT ETKİLİ VE
YASTIKLAMALI SİLİNDİR

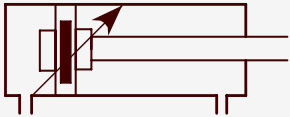

PST-A
ÇİFT ETKİLİ,
YASTIKLAMALI VE
MANYETİKLİ SİLİNDİR

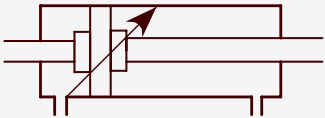

PST-D
ÇİFT ETKİLİ,
YASTIKLAMALI VE
ÇİFT MİLLİ SİLİNDİR

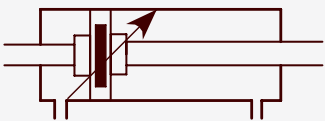

PST-AD
ÇİFT ETKİLİ, YASTIKLAMALI,
MANYETİKLİ VE ÇİFT MİLLİ
SİLİNDİR

Bu ürünlerde yastıklama standarttır.

ÇALIŞMA ŞARTLARI

Çalışma akışkanı:

Filtrelenmiş ve yağlanmış ya da filtrelenmiş ve yağsız hava

Çalışma sıcaklık derecesi:

Poliüretan (PU) : (-20°C) - (+80°C)
Viton (FKM) : (-30°C) - (+150°C)

Maksimum çalışma basıncı:

10 Bar

- SAPLAMALI BAĞLANTI SAYESİNDE DIŞ ETKENLERE DAYANIM
- GENİŞ BAĞLANTI EKİPMANLARIYLA KOLAY MONTAJ
- TOZLU VE KİRLİ ORTAMLARA UYGUN MİL KEÇESİ OPSİYONU (K5)
- METAL SIYIRICI OPSİYONU (K6)

KUVVET DEĞERİ

| Silindir Ø mm | Mil Ø mm | İtme ve Çekme kuvvetleri (6 Bar) | |
|------------------|-------------|----------------------------------|-------------------|
| | | İtme kuvveti (N) | Çekme kuvveti (N) |
| 32 | 12 | 482 | 415 |
| 40 | 16 | 754 | 633 |
| 50 | 20 | 1178 | 990 |
| 63 | 20 | 1870 | 1682 |
| 80 | 25 | 3016 | 2721 |
| 100 | 25 | 4712 | 4418 |
| 125 | 32 | 7363 | 6881 |

STANDART DIŞI VARYASYONLAR

- R1: Paslanmaz çelik silindir mili (SS 304, SS 316)
R3: Kapak bağlantı civataları (SS 304)
R4: Mil ucu somunu paslanmaz çelik (SS 304)
R5: Silindir mili CK 45 çelik (Sert krom kaplamalı)
M1: Silindir milinde uzatılmış erkek diş
M2: Dişi diş açılmış silindir mili
M3: Silindir mili özel diş ölçüsü
M4: Uzatılmış silindir mili
E1: Korozyona karşı dayanıklı alüminyum kapaklar (Sert eloksal kaplamalı)
K1: Maksimum 150°C sızdırmazlık elemanları (Viton)
K2: Mil keçesi NBR+PA
K3: Sızdırmazlık elemanları NBR
K4: Mil keçesi viton
K5: Tozlu ve kirli ortamlar için sıyrıcı (PU+POM)
K6: Yoğun kirli ve tozlu ortamlar için metal sıyrıcı (Bronz+PU)

SİPARİŞ ÖRNEĞİ

| | | | |
|-----------|------------------|-----------------------|----------------------------|
| PST | 050 - 0100 | EB ÇB | K4 |
| Ürün kodu | Silindir Ø Strok | Silindir bağlantıları | Standart dışı varyasyonlar |

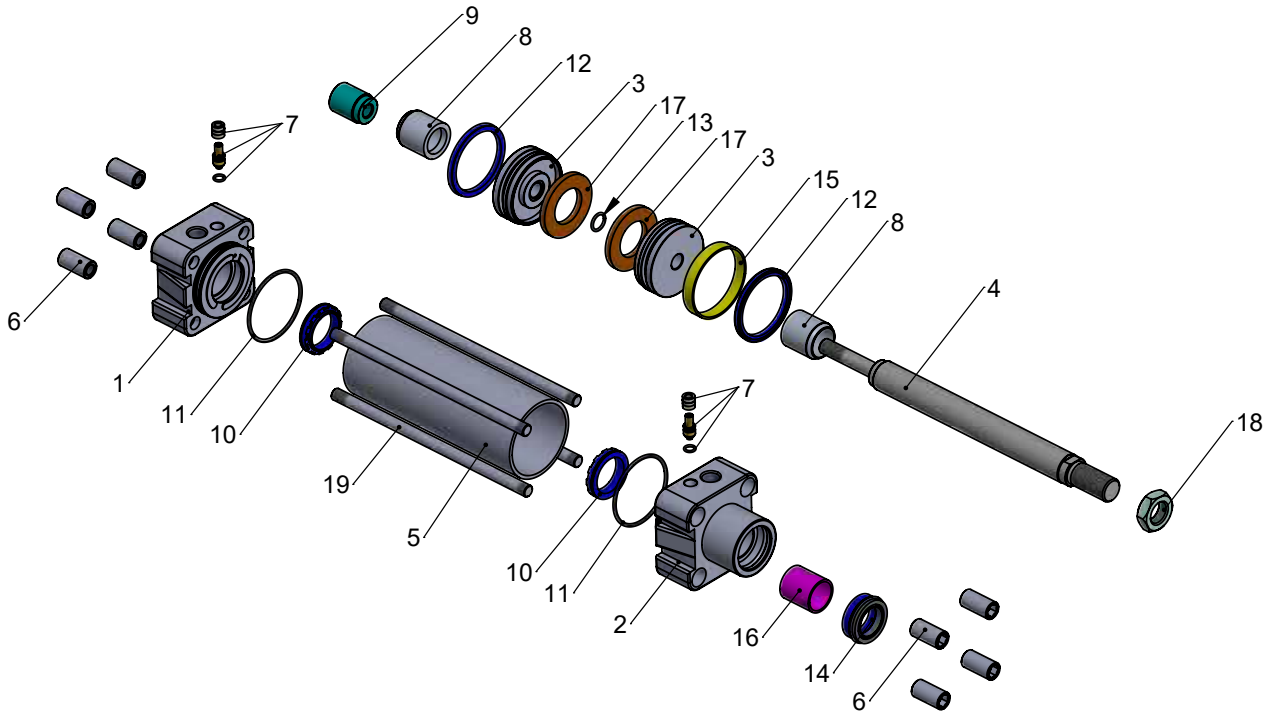
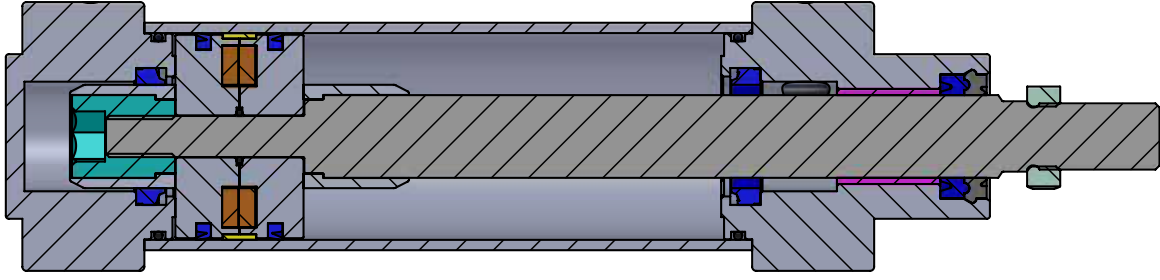

| No | Malzeme adı | Malzeme özelliği | Adet |
|----|---------------------|-----------------------------|------|
| 1 | Arka Kapak | Alüminyum | 1 |
| 2 | Ön Kapak | Alüminyum | 1 |
| 3 | Orta Piston | Alüminyum | 2 |
| 4 | Piston Mili | X20Cr13 Sert Krom Kaplamalı | 1 |
| 5 | Boru | Alüminyum+Eloksal Kaplamalı | 1 |
| 6 | Civata | Galvaniz Kaplamalı Çelik | 8 |
| 7 | Yastıklama Vidası | Pirinç + AISI 303 +NBR | 2 |
| 8 | Yastıklama Borusu | Polyacetal | 2 |
| 9 | Yastıklama Dişlisi | Galvaniz Kaplamalı Çelik | 1 |
| 10 | Yastıklama Keçesi | PU | 2 |
| 11 | Kapak O-ringi | NBR | 2 |
| 12 | Piston Keçesi | PU | 2 |
| 13 | Orta Piston O-ringi | NBR | 1 |
| 14 | Mil Keçesi | HYTREL+PU | 1 |
| 15 | Yataklama Bandı | Polyacetal | 1 |
| 16 | Yataklama Burcu | CSB-40 | 1 |
| 17 | Mıknatis | | 2 |
| 18 | Somun | Galvaniz Kaplamalı Çelik | 1 |
| 19 | Saplama | SS 304 | 4 |

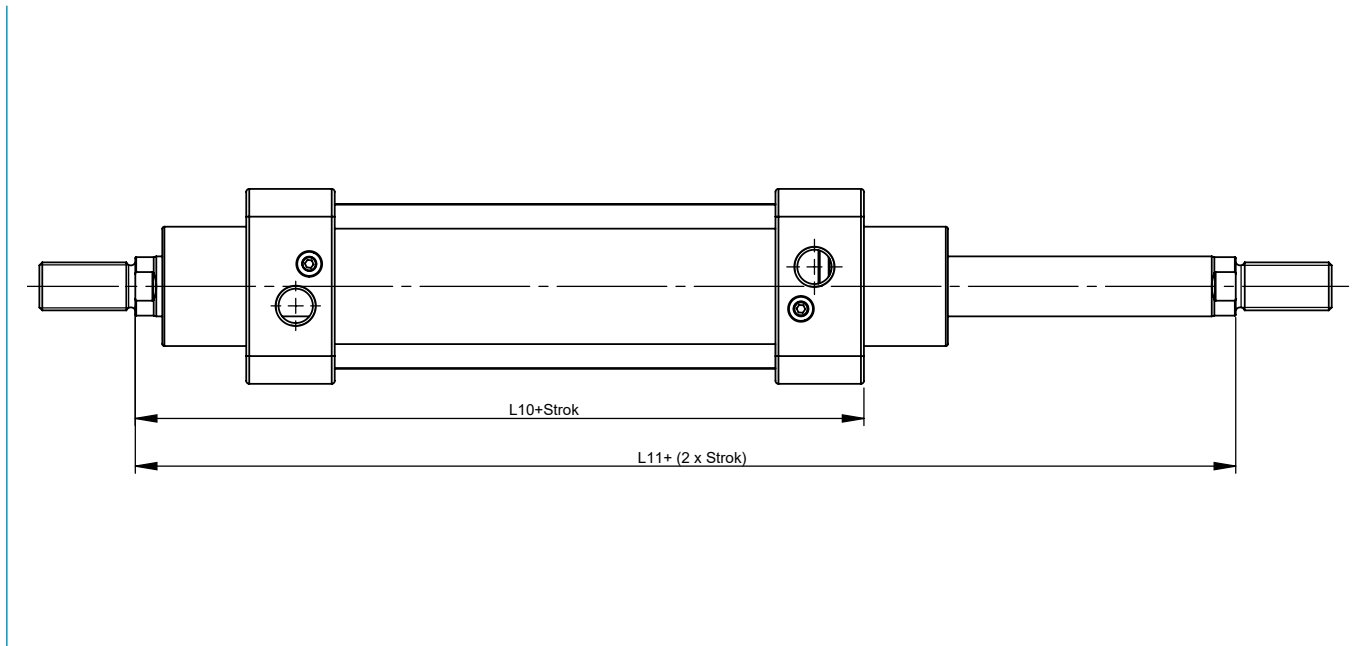
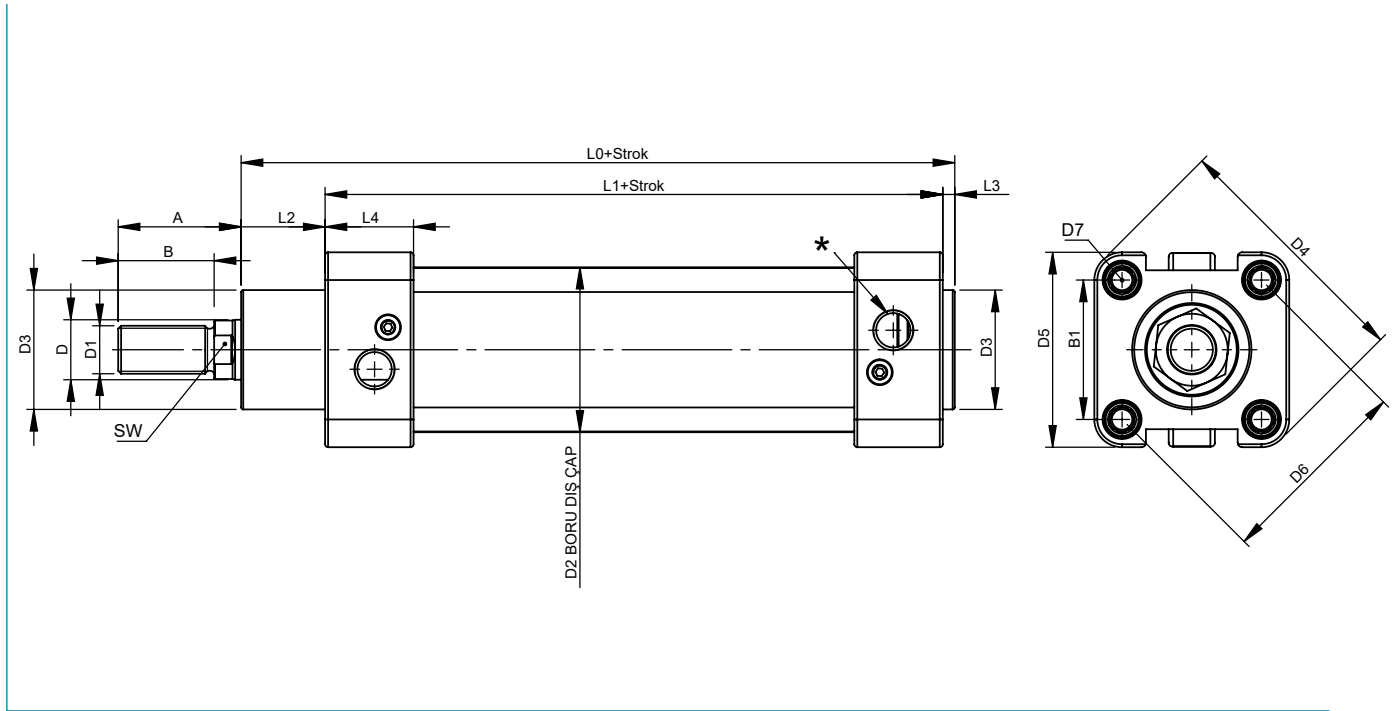

| Silindir Ø mm | A | B | B1 | D Ø | D1 | D2 Ø | D3 Ø | D4 | D5 | D6 Ø | D7 | L0 | L1 | L2 | L3 | L4 | L10 | L11 | SW | * |
|---------------|------|----|------|-----|----------|------|------|-------|-----|-------|-----|-------|-----|------|----|------|-----|-----|----|-------|
| 32 | 30 | 22 | 32,5 | 12 | M10x1.25 | 37 | 30 | 59 | 45 | 46 | M6 | 116 | 94 | 18 | 4 | 25 | 120 | 146 | 10 | G1/8" |
| 40 | 34 | 24 | 38 | 16 | M12x1.25 | 45 | 35 | 70,2 | 54 | 53,7 | M6 | 129 | 105 | 20 | 4 | 27 | 135 | 165 | 13 | G1/4" |
| 50 | 41 | 32 | 46,5 | 20 | M16x1.5 | 55 | 40 | 84,2 | 65 | 65,7 | M8 | 138 | 106 | 28 | 4 | 29,5 | 143 | 180 | 17 | G1/4" |
| 63 | 42 | 32 | 56,5 | 20 | M16x1.5 | 68 | 45 | 99,5 | 76 | 80 | M8 | 152 | 121 | 27 | 4 | 34,5 | 158 | 195 | 17 | G3/8" |
| 80 | 52 | 40 | 72 | 25 | M20x1.5 | 85 | 45 | 123,8 | 94 | 101,8 | M10 | 167 | 128 | 34 | 4 | 35 | 174 | 220 | 22 | G3/8" |
| 100 | 52,5 | 40 | 89 | 25 | M20x1.5 | 107 | 55 | 148,8 | 112 | 125,9 | M10 | 182,5 | 138 | 38,5 | 4 | 38 | 189 | 240 | 22 | G1/2" |
| 125 | 73 | 54 | 110 | 32 | M27x2 | 133 | 60 | 179,5 | 134 | 155,5 | M12 | 213 | 160 | 46 | 6 | 44 | 225 | 290 | 27 | G1/2" |



FB Flanş Bağlantı

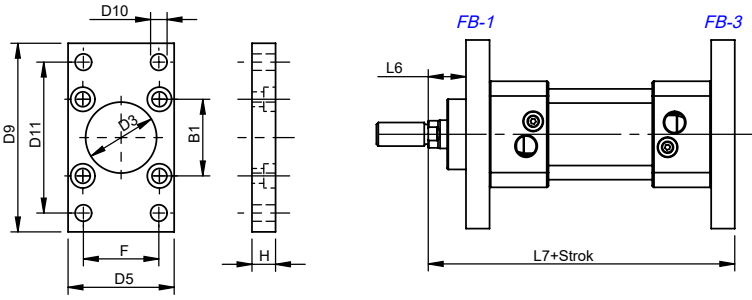

OEKB Orta Eklem Kapak Bağlantı

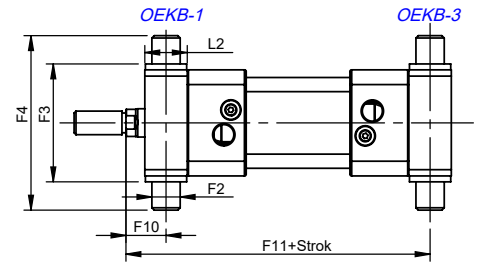

AB Ayak Bağlantı

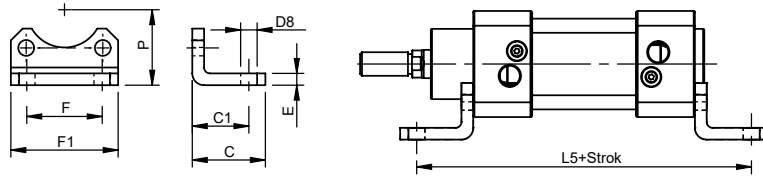

OEB-3 Orta Eklem Bağlantı

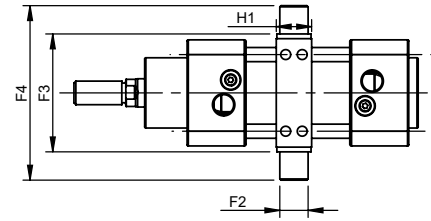

EB Eklem Bağlantı

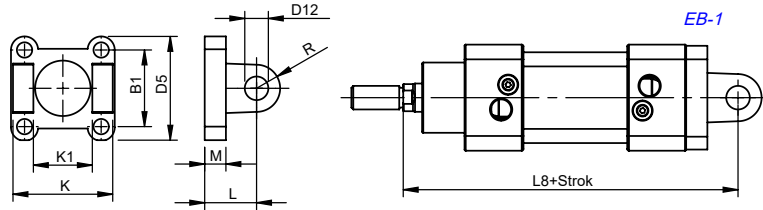

DMB Destek Mafsal Bağlantı

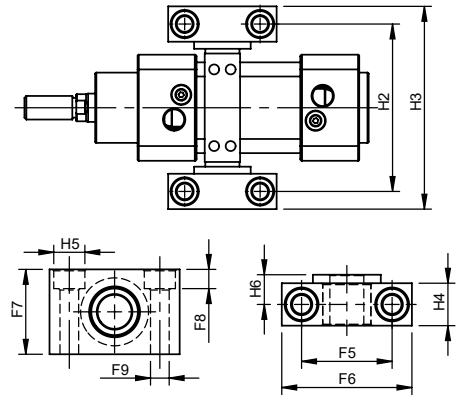

YB Yer Bağlantı

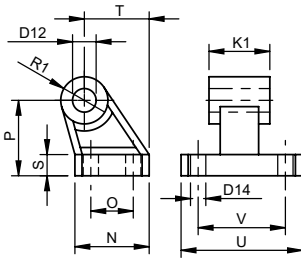

EYB Eklem Yer Bağlantı

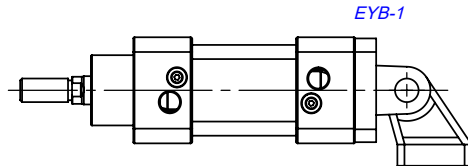

| Silindir Ø mm | B1 | C | C1 | D3 Ø H11 | D5 | D8 Ø H14 | D9 | D10 Ø H13 | D11 JS14 | D12 Ø H9 | D14 Ø H13 | E | F | F1 | F2 Ø e9 | F3 h14 | F4 | F5 ±0,2 | F6 | F7 | F8 | F9 Ø H13 | F10 | F11 |
|------------------|------|----|----|----------------|-----|----------------|-----|-----------------|-------------|----------------|-----------------|---|----|------|---------------|-----------|-----|------------|----|----|-----|----------------|------|-------|
| 32 | 32.5 | 30 | 24 | 30 | 45 | 7 | 80 | 7 | 64 | 10 | 6.6 | 5 | 32 | 45.5 | 12 | 50 | 74 | 32 | 46 | 30 | 6.8 | 6.6 | 17 | 129 |
| 40 | 38 | 37 | 28 | 35 | 54 | 10 | 90 | 9 | 72 | 12 | 6.6 | 5 | 36 | 54.5 | 16 | 63 | 95 | 36 | 55 | 36 | 9 | 9 | 20 | 145 |
| 50 | 46.5 | 41 | 32 | 40 | 65 | 10 | 110 | 9 | 90 | 12 | 9 | 6 | 45 | 65 | 16 | 75 | 107 | 36 | 55 | 36 | 9 | 9 | 23 | 157 |
| 63 | 56.5 | 44 | 32 | 45 | 76 | 10 | 120 | 9 | 100 | 16 | 9 | 6 | 50 | 76 | 20 | 90 | 130 | 42 | 65 | 40 | 11 | 11 | 23.5 | 171.5 |
| 80 | 72 | 56 | 41 | 45 | 94 | 12 | 150 | 12 | 126 | 16 | 11 | 6 | 63 | 94 | 20 | 110 | 150 | 42 | 65 | 40 | 11 | 11 | 29 | 191 |
| 100 | 89 | 58 | 41 | 55 | 112 | 14 | 175 | 14 | 150 | 20 | 11 | 6 | 75 | 112 | 25 | 132 | 182 | 50 | 75 | 50 | 13 | 14 | 31.8 | 208.3 |
| 125 | 110 | 67 | 45 | 60 | 134 | 16 | 210 | 16 | 180 | 25 | 14 | 8 | 90 | 131 | 25 | 160 | 210 | 50 | 75 | 50 | 13 | 14 | 42 | 248 |

| Silindir Ø mm | H | H1 -0,2 | H2 | H3 | H4 | H5 H13 | H6 Ø | K h14 | K1 H14 | L | L2 | L5 | L6 | L7 | L8 | M | N | O JS14 | P JS16 | R | R1 | S | T | U | V JS14 |
|------------------|----|------------|-----|-----|------|-----------|---------|----------|-----------|----|------|-----|----|-----|-----|----|----|-----------|-----------|----|------|----|------|-----|-----------|
| 32 | 10 | 28 | 71 | 86 | 15 | 11 | 10.5 | 45 | 26 | 22 | 18 | 142 | 16 | 130 | 142 | 9 | 31 | 18 | 32 | 10 | 10 | 8 | 27.5 | 51 | 38 |
| 40 | 10 | 28 | 87 | 105 | 18 | 15 | 12 | 52 | 28 | 25 | 20 | 161 | 20 | 145 | 160 | 9 | 35 | 22 | 36 | 12 | 11 | 10 | 30.5 | 54 | 41 |
| 50 | 12 | 34 | 99 | 117 | 18 | 15 | 12 | 60 | 32 | 27 | 28 | 170 | 25 | 155 | 170 | 11 | 45 | 30 | 45 | 13 | 13 | 12 | 40.5 | 65 | 50 |
| 63 | 12 | 34 | 116 | 136 | 20 | 18 | 13 | 70 | 40 | 32 | 27 | 185 | 25 | 170 | 190 | 11 | 50 | 35 | 50 | 16 | 15 | 12 | 44.5 | 67 | 52 |
| 80 | 16 | 34 | 136 | 156 | 20 | 18 | 13 | 90 | 50 | 36 | 34 | 210 | 30 | 190 | 210 | 14 | 60 | 40 | 63 | 16 | 15 | 14 | 57 | 86 | 66 |
| 100 | 16 | 44 | 164 | 189 | 24.5 | 20 | 16 | 110 | 60 | 41 | 38.5 | 220 | 35 | 205 | 230 | 14 | 70 | 50 | 71 | 20 | 19 | 15 | 65 | 96 | 76 |
| 125 | 20 | 44 | 192 | 217 | 24.5 | 20 | 16 | 130 | 70 | 50 | 46 | 250 | 45 | 245 | 275 | 15 | 90 | 60 | 90 | 25 | 22.5 | 20 | 85 | 124 | 94 |

FB Flanş Bağlantı



AB Ayak Bağlantı

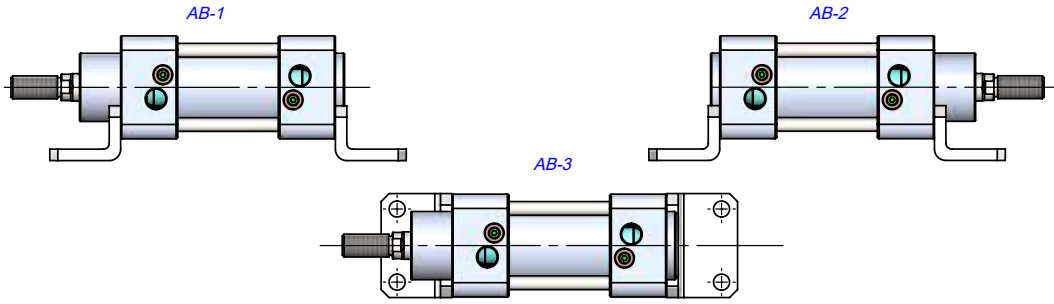

EB Eklem Bağlantı



EYB Eklem Yer Bağlantı

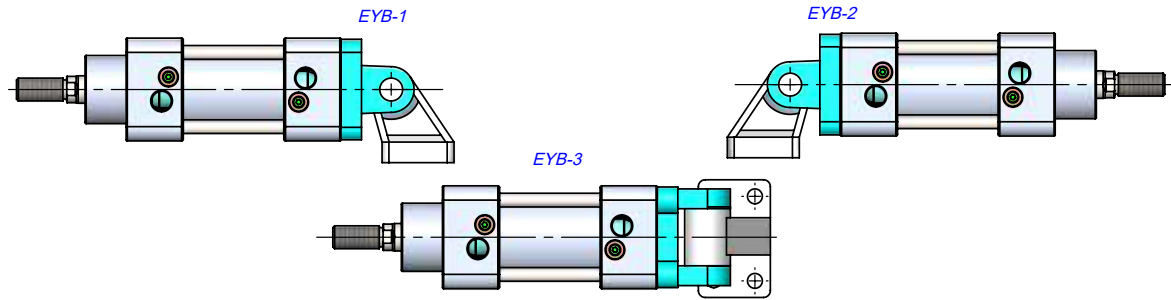

OEKB Orta Eklem Kapak Bağlantı



OEB Orta Eklem Bağlantı

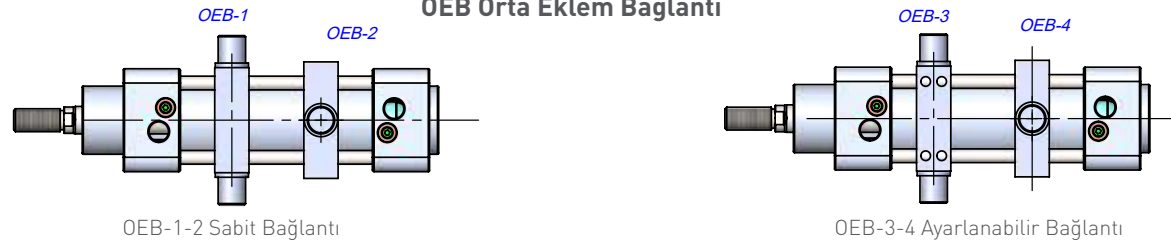

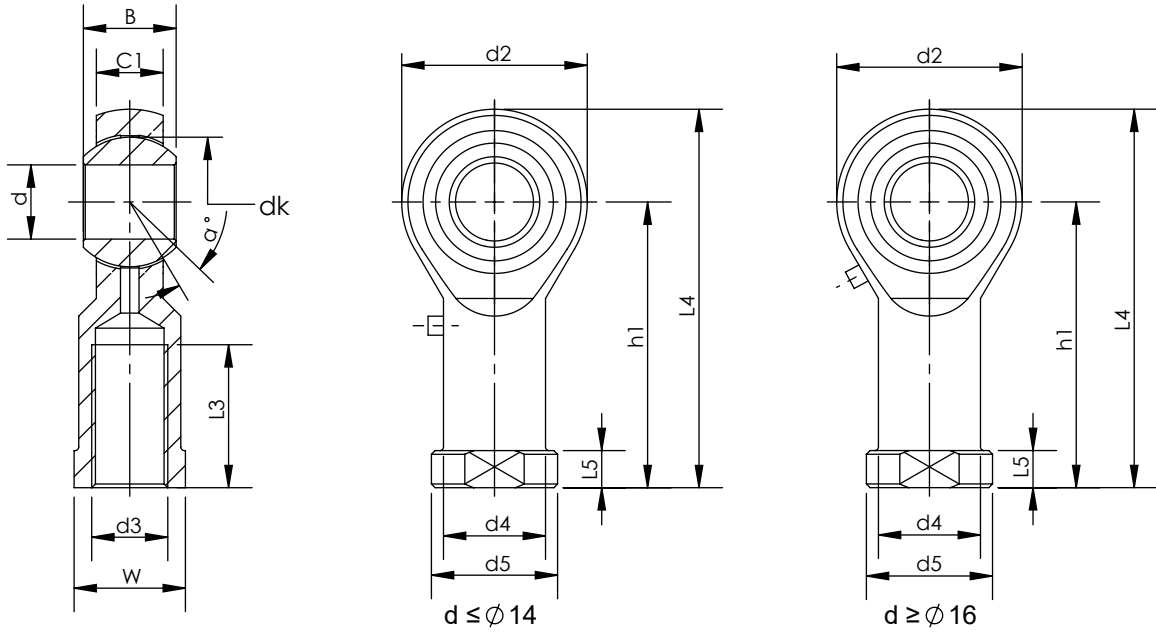

| Parça No. | Ölçüler mm | | | | | | | | | | | | | |
|-----------|------------|----------|----|------|----|-----------|----|-----|-----|-----|------|----|--------|----|
| | d | d3 6H | B | C1 | W | L3 min | d2 | L4 | h1 | L5 | d4 | d5 | dk | α° |
| KMB 10 -1 | 10 | M10x1.25 | 14 | 10.5 | 17 | 20 | 26 | 56 | 43 | 6.5 | 15 | 19 | 19.05 | 13 |
| KMB 12 -1 | 12 | M12x1.25 | 16 | 12 | 19 | 22 | 30 | 65 | 50 | 6.5 | 17.5 | 22 | 22.225 | 13 |
| KMB 16 -1 | 16 | M16x1.5 | 21 | 15 | 22 | 28 | 40 | 84 | 64 | 8 | 22 | 27 | 28.575 | 15 |
| KMB 20 | 20 | M20x1.5 | 25 | 18 | 30 | 33 | 50 | 102 | 77 | 10 | 27.5 | 34 | 34.925 | 14 |
| KMB 28 | 28 | M27x2 | 35 | 24 | 41 | 48 | 66 | 136 | 103 | 14 | 37 | 46 | 47.6 | 15 |
| KMB 30-1 | 30 | M27x2 | 37 | 25 | 41 | 51 | 70 | 145 | 110 | 15 | 40 | 50 | 50.8 | 17 |
| KMB 30 | 30 | M30x2 | 37 | 25 | 41 | 51 | 70 | 145 | 110 | 15 | 40 | 50 | 50.8 | 17 |

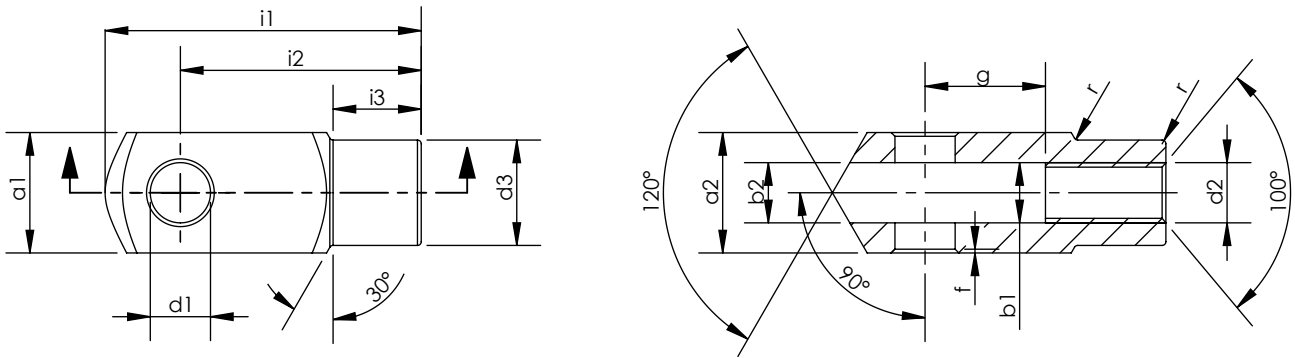

| Silindir Ø mm | d1 H9 | g ±0,5 | a1 h 11 | a2 +0,3 -0,16 | b1 B 13 | b2 | d2 6H | d3 ±0,3 | f ±0,2 | i1 ±0,5 | i2 | i3 ±0,2 | r |
|------------------|----------|-----------|------------|---------------------|------------|----|----------|------------|-----------|------------|-----|------------|-----|
| 32 | 10 | 20 | 20 | 20 | 10 | 10 | M10x1.25 | 18 | 0.5 | 52 | 40 | 15 | 0.5 |
| 40 | 12 | 24 | 24 | 24 | 12 | 12 | M12x1.25 | 20 | 0.5 | 62 | 48 | 18 | 0.5 |
| 50 | 16 | 32 | 32 | 32 | 16 | 16 | M16x1.5 | 26 | 1 | 83 | 64 | 24 | 1 |
| 63 | 16 | 32 | 32 | 32 | 16 | 16 | M16x1.5 | 26 | 1 | 83 | 64 | 24 | 1 |
| 80 | 20 | 40 | 40 | 40 | 20 | 20 | M20x1.5 | 34 | 1.5 | 105 | 80 | 30 | 1.5 |
| 100 | 20 | 40 | 40 | 40 | 20 | 20 | M20x1.5 | 34 | 1.5 | 105 | 80 | 30 | 1.5 |
| 125 | 25 | 50 | 50 | 50 | 25 | 25 | M27x2 | 42 | 1.5 | 132 | 100 | 36 | 1.5 |